



Motor Specialty, Inc.
2801 Lathrop Avenue
Racine, WI 53405

DESCRIPTION: 2000C GM 30 GEARBOX .750" SHAFT DROP-IN

DRAWN BY: CZ

PART NUMBER

MATERIAL:

SIZE: B

Model RGP2030C-GP7422

TOLERANCE: .XXX±.005 .XX±.01 FRACTION±1/64 ANGLE:±1 Deg.

SCALE: 1:1.5

ALL UNITS IN INCHES UNLESS OTHERWISE NOTED

REVISION: C

REVISIONS

REV.	DESCRIPTION	DATE	ENGINEERING APPROVAL
A	INITIAL DRAWING	10/30/19	CZ
B	MODEL NUMBER CHANGE (RGP)	3/30/2020	CZ
C	SHAFT EXTENSION CORRECTION	6/15/2020	CZ

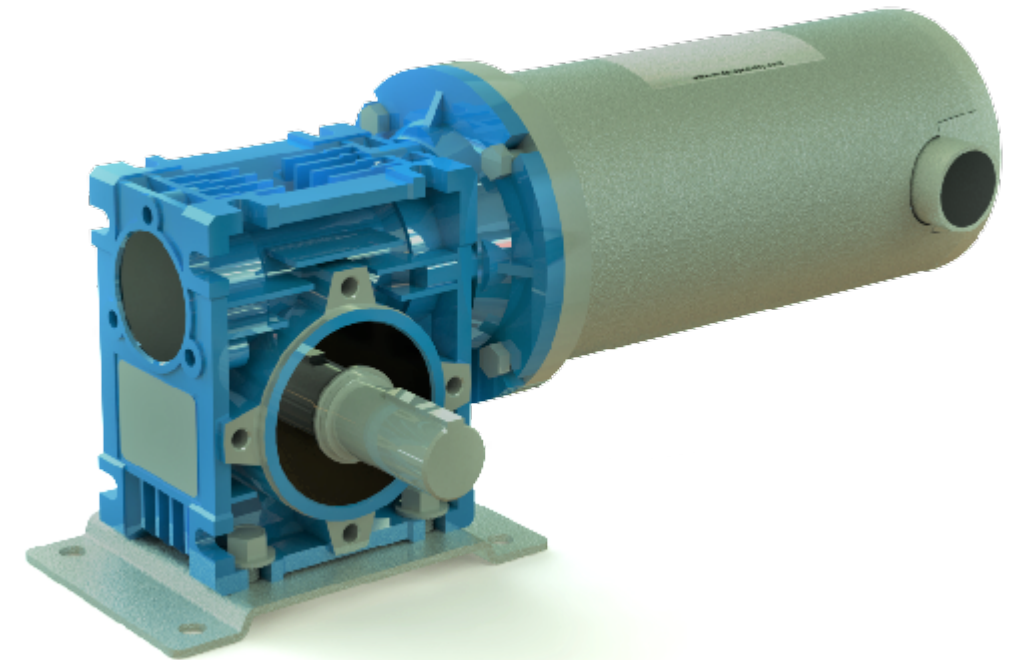
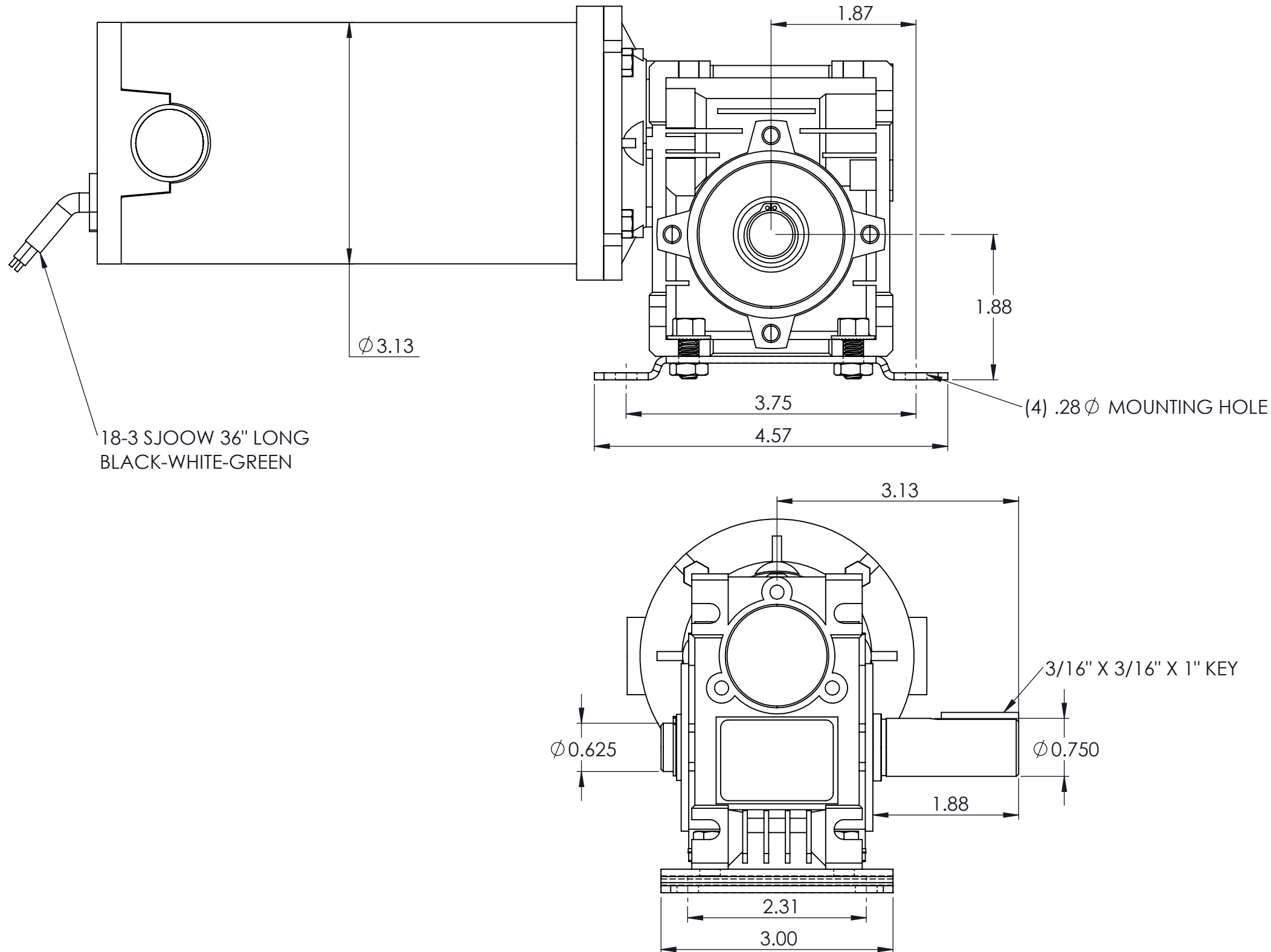

VOLTAGE: 180 DC
 ROTATION: REVERSIBLE (BLACK POSITIVE(+)) CW
 CONSTRUCTION: TENV
 FINISH: POWERCOAT SILVER/BLUE
 INSULATION: CLASS F
 GEAR REDUCTION: 30:1
 OUTPUT SPEED/TORQUE: 52RPM/75IN-LB