



Motor Specialty, Inc.
2801 Lathrop Avenue
Racine, WI 53405

DESCRIPTION: 2000C PM 40 GEARBOX .75" SHAFT DROP-IN

DRAWN BY: CZ

PART NUMBER

MATERIAL:

SIZE: B

TOLERANCE: .XXX±.005 .XX±.01 FRACTION±1/64 ANGLE:±1 Deg.

SCALE: 1:2

Model RGP2040C-GPF13516

ALL UNITS IN INCHES UNLESS OTHERWISE NOTED

REVISION: -

REVISIONS

REV.	DESCRIPTION	DATE	ENGINEERING APPROVAL
-	INITIAL DRAWING	10/16/2020	CZ

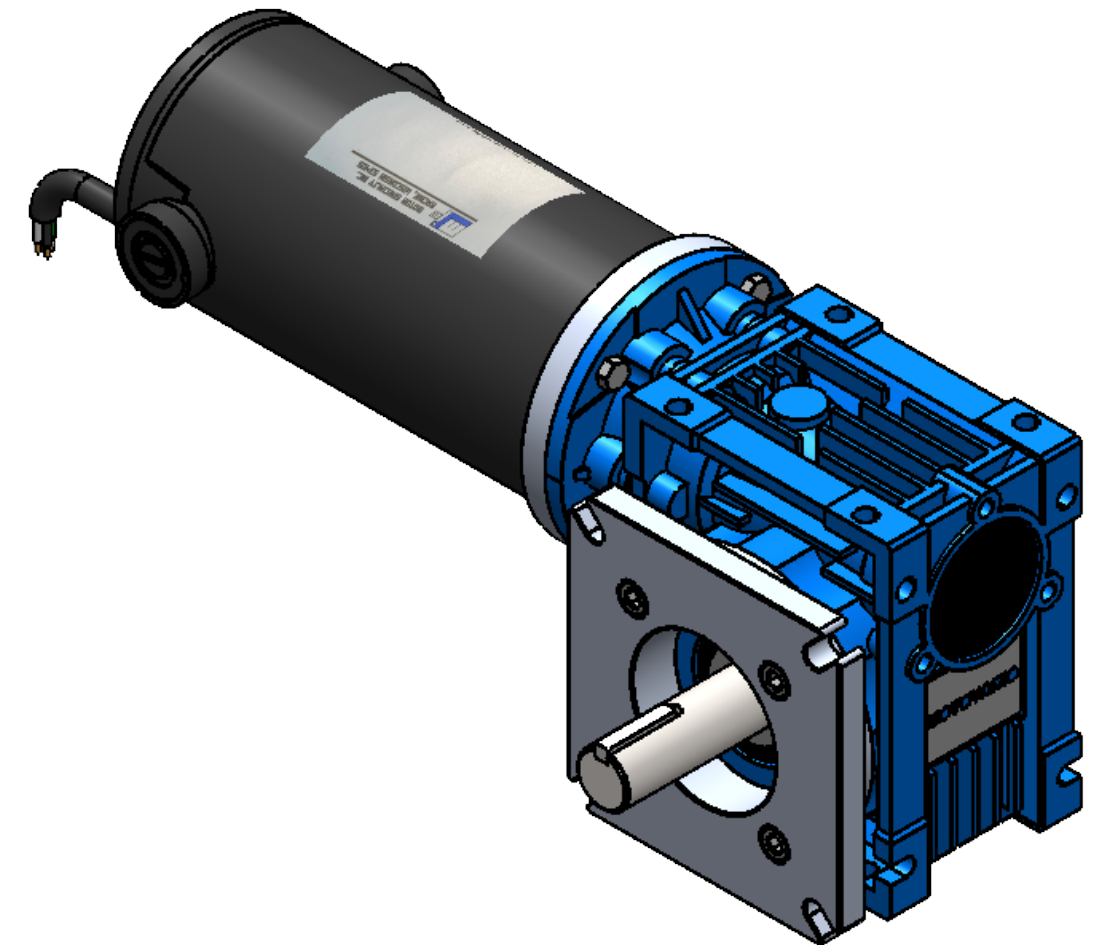
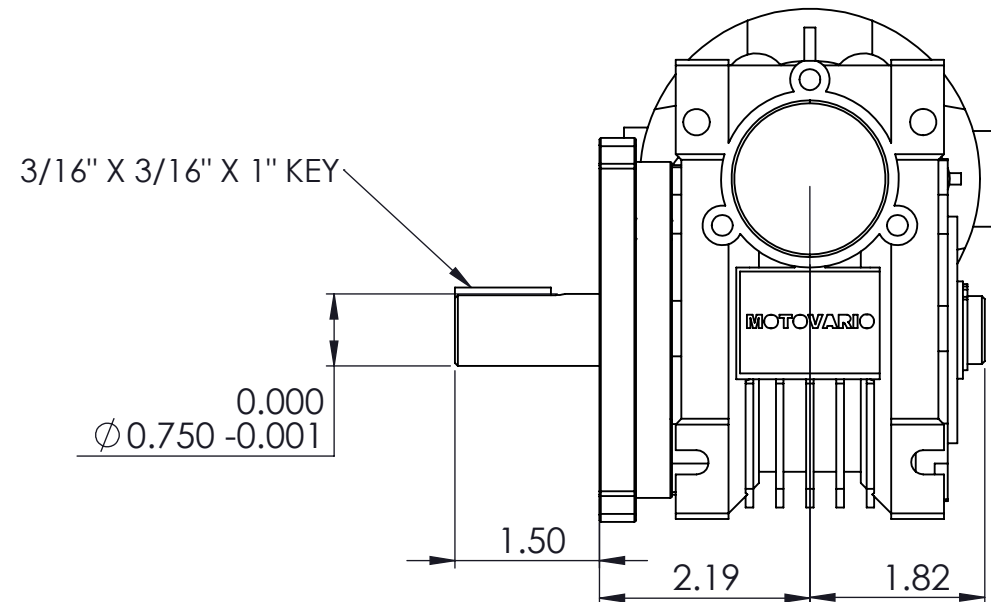
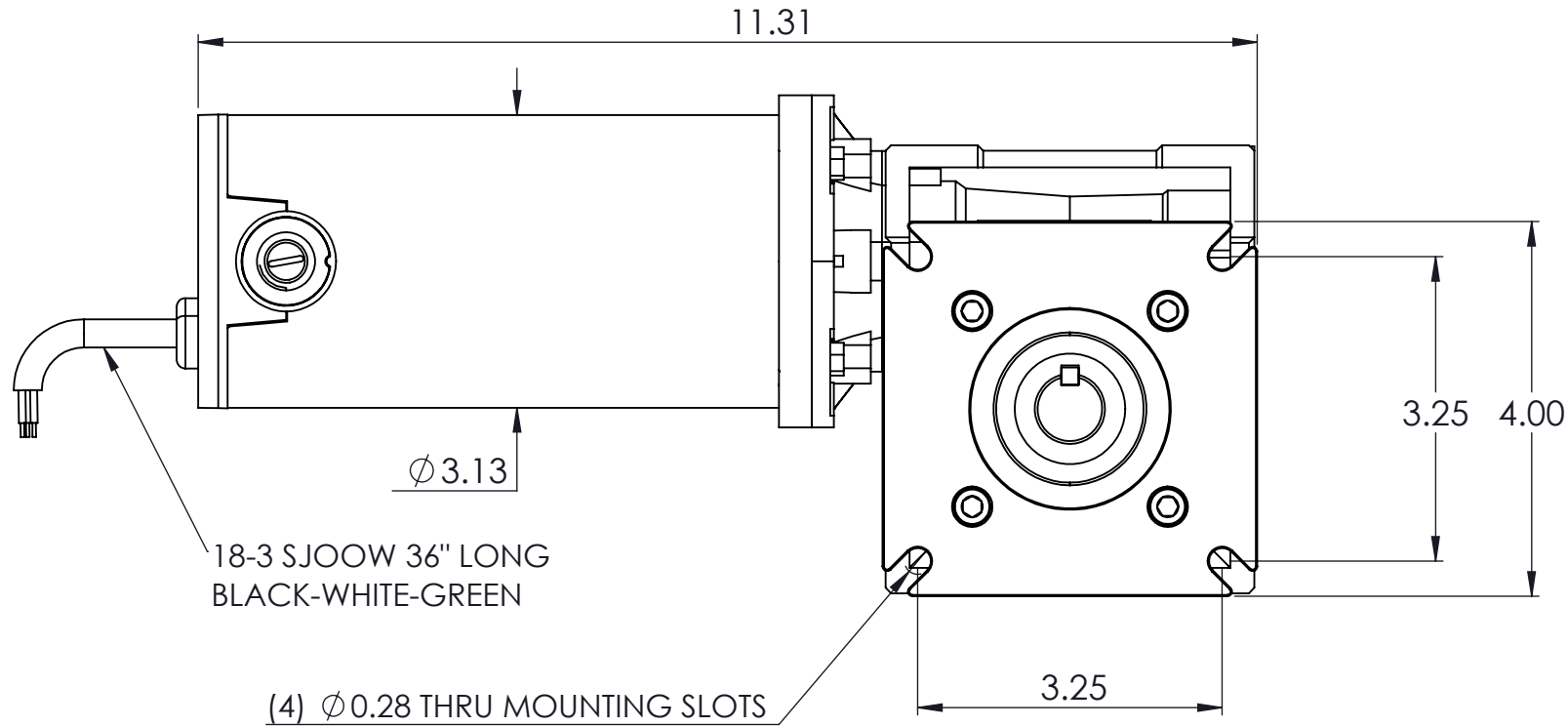

VOLTAGE: 90 DC
 ROTATION: REVERSIBLE (BLACK POSITIVE(+) CW)
 CONSTRUCTION: TENV
 FINISH: POWDERCOAT BLACK/BLUE
 INSULATION: CLASS F
 GEAR REDUCTION: 20:1
 OUTPUT SPEED/TORQUE: 111RPM/96IN-LB